

# P80 Six

12-Channel Electrocardiograph - User Guide - English  
Electrocardiógrafo de 12 Canales - Guía para el Usuario - Español  
Electrocardiógrafo de 12-Canais - Manual do Utilizador - Português

# ESAOTE

*ESAOTE S.P.A*

*Via Di Caciolle 15*

*50127 Firenze*

*Italy*

*Tel: +39 0 55 4229 1*

*Fax: +39 0 55 4229 208*

*Internet Web Site <http://www.esaote.com>*

# P80 Six

12-Channel Electrocardiograph - User Guide - English  
Electrocardiógrafo de 12 Canales - Guía para el Usuario - Español  
Electrocardiógrafo de 12-Canais - Manual do Utilizador - Português

# ESAOTE

*ESAOTE S.P.A*

*Via Di Caciolle 15*

*50127 Firenze*

*Italy*

*Tel: +39 0 55 4229 1*

*Fax: +39 0 55 4229 208*

*Internet Web Site <http://www.esaote.com>*

**P80Six User Guide - English**  
**Guía para el Usuario del P80Six - Español**  
**Manual do Utilizador de P80Six - Português**

**Article Number: 9740440015**

7. 1998 b. 11.2000 c. 6.2001

**Associated Documents**

Guide to the Interpretation and Measurement Program E/ D  
Article Number 9740440008

Distributed by:  
**ESAOTE S.P.A**  
**Via Di Caciolle 15**  
**50127 Firenze**  
**Italy**  
**TEL: +39 0 55 4229 1**  
**FAX: +39 0 55 4229 208**

Manufactured by:  
**SCHILLERAG**  
**Altgasse 68**  
**CH-6340 Baar, Switzerland**

SAG (2.510286 c)

**CE 0123**

93/42/EEC Medical Devices:  
0123 `Notified Body` TÜV P. S.

**P80Six User Guide - English**  
**Guía para el Usuario del P80Six - Español**  
**Manual do Utilizador de P80Six - Português**

**Article Number: 9740440015**

7. 1998 b. 11.2000 c. 6.2001

**Associated Documents**

Guide to the Interpretation and Measurement Program E/ D  
Article Number 9740440008

Distributed by:  
**ESAOTE S.P.A**  
**Via Di Caciolle 15**  
**50127 Firenze**  
**Italy**  
**TEL: +39 0 55 4229 1**  
**FAX: +39 0 55 4229 208**

Manufactured by:  
**SCHILLERAG**  
**Altgasse 68**  
**CH-6340 Baar, Switzerland**

SAG (2.510286 c)

**CE 0123**

93/42/EEC Medical Devices:  
0123 `Notified Body` TÜV P. S.

## DECLARATION OF CONFORMITY

Electrocardiograph: **ESAOTE P-80 Six**

We, the undersigned, hereby declare that the medical device (class II a) specified above conforms with the Essential Requirements listed in Annex I, of EC Directive 93/42/EEC

**This declaration is supported by:**

TÜV Product Service GmbH, Management Service, D – 80339 Munich

**Certificate of approval No:**

Q1Z 01 03 41505 002      DIN EN ISO 9001:2000 / DIN EN 46001:1996

G1 01 03 41505 001      Annex II, Section 3 of the Directive 93/42/EEC Medical Devices

Valid date 02/2004.

CE 0123

Baar (Switzerland), 21.03.2001

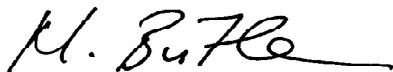

Markus Bütler  
Quality Assurance Manager

## DECLARATION OF CONFORMITY

Electrocardiograph: **ESAOTE P-80 Six**

We, the undersigned, hereby declare that the medical device (class II a) specified above conforms with the Essential Requirements listed in Annex I, of EC Directive 93/42/EEC

**This declaration is supported by:**

TÜV Product Service GmbH, Management Service, D – 80339 Munich

**Certificate of approval No:**

Q1Z 01 03 41505 002      DIN EN ISO 9001:2000 / DIN EN 46001:1996

G1 01 03 41505 001      Annex II, Section 3 of the Directive 93/42/EEC Medical Devices

Valid date 02/2004.

CE 0123

Baar (Switzerland), 21.03.2001

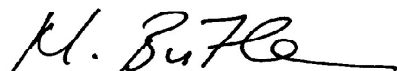

Markus Bütler  
Quality Assurance Manager

***Donde Obtener Servicio y Asesoramiento Comercial***  
***Onde obter Assistência Técnica e de Vendas***

USA: BIOSOUND Inc.  
8000 Castleway Drive  
PO Box 50858 Indianapolis  
Indiana 46250 - 0858  
Tel: +1 (317) 849 1793  
Fax: +1 (317) 841 8616

Russia: ESAOTE S.p.a  
Moscow Representative Office  
Khlebniy per., 27  
121063 Moscow  
Russia  
Tel: +7 (095) 232 1833  
Fax: +7 (095) 232 0205

Italy: ESAOTE S.p.a  
Via di Caciolle 15  
50127 Firenze  
Italy  
Tel: +39 055 4229 238  
Fax: +39 055 414 899

All other Countries: ESAOTE S.p.a  
Via di Caciolle 15  
50127 Firenze  
Italy  
Tel: +39 055 4229 1  
Fax: +39 055 4229 208  
Internet Web Site <http://www.esaote.com>

***Where to Obtain Service and Sales Advice***  
***Donde Obtener Servicio y Asesoramiento Comercial***  
***Onde obter Assistência Técnica e de Vendas***

USA: BIOSOUND Inc.  
8000 Castleway Drive  
PO Box 50858 Indianapolis  
Indiana 46250 - 0858  
Tel: +1 (317) 849 1793  
Fax: +1 (317) 841 8616

Russia: ESAOTE S.p.a  
Moscow Representative Office  
Khlebniy per., 27  
121063 Moscow  
Russia  
Tel: +7 (095) 232 1833  
Fax: +7 (095) 232 0205

Italy: ESAOTE S.p.a  
Via di Caciolle 15  
50127 Firenze  
Italy  
Tel: +39 055 4229 238  
Fax: +39 055 414 899

All other Countries: ESAOTE S.p.a  
Via di Caciolle 15  
50127 Firenze  
Italy  
Tel: +39 055 4229 1  
Fax: +39 055 4229 208  
Internet Web Site <http://www.esaote.com>

**Disclaimer**

The Information in this guide has been carefully checked for reliability; however no guarantee is given as to the correctness of the contents and SCHILLER makes no representations or warranties regarding the contents of this manual. We reserve the right to revise this document and make changes in the specification of the product described within at any time without obligation to notify any person of such revision or change.

**Copyright Notice**

© Copyright 1996 & 1998 by SCHILLER AG. All rights reserved. You may not reproduce, transmit, transcribe, store in a retrieval system or translate into any language, in any form or by any means, electronic, mechanical, magnetic, optical, chemical, manual or otherwise, any part of this publication without express written permission of SCHILLER AG.

**Terms of Warranty**

The ESAOTE P80Six is warranted against defects in material and manufacture for the duration of one year (as from date of purchase). Excluded from this guarantee is damage caused by an accident or as a result of improper handling. The warranty entitles free replacement of the defective part. Any liability for subsequent damage is excluded. The warranty is void if unauthorized or unqualified persons attempt to make repairs.

In case of a defect, contact your dealer or the manufacturer.

The manufacturer can only be held responsible for the safety, reliability, and performance of the apparatus if:

- assembly operations, extensions, readjustments, modifications, or repairs are carried out by persons authorized by him, and
- the P80Six and approved attached equipment are used in accordance with the manufacturers instructions.

---

*THERE ARE NO EXPRESS OR IMPLIED WARRANTIES WHICH EXTEND BEYOND THE WARRANTIES HEREINABOVE SET FORTH. ESAOTE MAKES NO WARRANTY OF MERCHANTABILITY OR FITNESS FOR A PARTICULAR PURPOSE WITH RESPECT TO THE PRODUCT OR PARTS THEREOF.*

---

**About this Handbook**

The philosophy of the manufacturer is one of continuous improvement. Our aim is to provide the user with the most up-to-date information and the latest technological developments.

Your suggestions and comments are welcome on all ESAOTE documentation. Please contact the ESAOTE Cardiology Corporate Marketing Department.

PHYSICIAN'S RESPONSIBILITY

THE P80SIX ELECTROCARDIOGRAPH IS PROVIDED FOR THE EXCLUSIVE USE OF QUALIFIED PHYSICIANS OR PERSONNEL UNDER THEIR DIRECT SUPERVISION. THE NUMERICAL AND GRAPHICAL RESULTS FROM A RECORDING MUST BE EXAMINED WITH RESPECT TO THE PATIENTS OVERALL CLINICAL CONDITION, THE RECORDING PREPARATION QUALITY AND THE GENERAL RECORDED DATA QUALITY, WHICH COULD EFFECT THE REPORT DATA ACCURACY, MUST ALSO BE TAKEN INTO ACCOUNT.

IT IS THE PHYSICIANS RESPONSIBILITY TO MAKE THE DIAGNOSIS OR TO OBTAIN EXPERT OPINION ON THE RESULTS, AND TO INSTITUTE CORRECT TREATMENT IF INDICATED.

FEDERAL LAW IN THE USA RESTRICTS THIS DEVICE TO SALE BY OR ON THE ORDER OF A PHYSICIAN

**Disclaimer**

The Information in this guide has been carefully checked for reliability; however no guarantee is given as to the correctness of the contents and SCHILLER makes no representations or warranties regarding the contents of this manual. We reserve the right to revise this document and make changes in the specification of the product described within at any time without obligation to notify any person of such revision or change.

**Copyright Notice**

© Copyright 1996 & 1998 by SCHILLER AG. All rights reserved. You may not reproduce, transmit, transcribe, store in a retrieval system or translate into any language, in any form or by any means, electronic, mechanical, magnetic, optical, chemical, manual or otherwise, any part of this publication without express written permission of SCHILLER AG.

**Terms of Warranty**

The ESAOTE P80Six is warranted against defects in material and manufacture for the duration of one year (as from date of purchase). Excluded from this guarantee is damage caused by an accident or as a result of improper handling. The warranty entitles free replacement of the defective part. Any liability for subsequent damage is excluded. The warranty is void if unauthorized or unqualified persons attempt to make repairs.

In case of a defect, contact your dealer or the manufacturer.

The manufacturer can only be held responsible for the safety, reliability, and performance of the apparatus if:

- assembly operations, extensions, readjustments, modifications, or repairs are carried out by persons authorized by him, and
- the P80Six and approved attached equipment are used in accordance with the manufacturers instructions.

---

*THERE ARE NO EXPRESS OR IMPLIED WARRANTIES WHICH EXTEND BEYOND THE WARRANTIES HEREINABOVE SET FORTH. ESAOTE MAKES NO WARRANTY OF MERCHANTABILITY OR FITNESS FOR A PARTICULAR PURPOSE WITH RESPECT TO THE PRODUCT OR PARTS THEREOF.*

---

**About this Handbook**

The philosophy of the manufacturer is one of continuous improvement. Our aim is to provide the user with the most up-to-date information and the latest technological developments.

Your suggestions and comments are welcome on all ESAOTE documentation. Please contact the ESAOTE Cardiology Corporate Marketing Department.

PHYSICIAN'S RESPONSIBILITY

THE P80SIX ELECTROCARDIOGRAPH IS PROVIDED FOR THE EXCLUSIVE USE OF QUALIFIED PHYSICIANS OR PERSONNEL UNDER THEIR DIRECT SUPERVISION. THE NUMERICAL AND GRAPHICAL RESULTS FROM A RECORDING MUST BE EXAMINED WITH RESPECT TO THE PATIENTS OVERALL CLINICAL CONDITION, THE RECORDING PREPARATION QUALITY AND THE GENERAL RECORDED DATA QUALITY, WHICH COULD EFFECT THE REPORT DATA ACCURACY, MUST ALSO BE TAKEN INTO ACCOUNT.

IT IS THE PHYSICIANS RESPONSIBILITY TO MAKE THE DIAGNOSIS OR TO OBTAIN EXPERT OPINION ON THE RESULTS, AND TO INSTITUTE CORRECT TREATMENT IF INDICATED.

FEDERAL LAW IN THE USA RESTRICTS THIS DEVICE TO SALE BY OR ON THE ORDER OF A PHYSICIAN

## Safety Notices

---

TO PREVENT ELECTRIC SHOCK DO NOT DISASSEMBLE THE UNIT. NO SERVICEABLE PARTS INSIDE. REFER SERVICING TO QUALIFIED PERSONNEL ONLY.

DO NOT USE THIS UNIT IN AREAS WHERE THERE IS ANY DANGER OF EXPLOSION OR THE PRESENCE OF FLAMMABLE GASES SUCH AS ANAESTHETIC AGENTS.

IN THE EVENT OF ACCIDENTAL LCD BREAKAGE AND RESULTANT LEAKAGE OF FLUID, DO NOT INHALE, INGEST OR MAKE CONTACT WITH THE SKIN. IF CONTACT IS MADE RINSE IMMEDIATELY.

THIS PRODUCT IS NOT DESIGNED FOR STERILE USE.

THIS PRODUCT IS NOT DESIGNED FOR OUTDOOR USE.

SWITCH THE UNIT OFF BEFORE CLEANING AND DISCONNECT FROM THE MAINS.

DO NOT, UNDER ANY CIRCUMSTANCES, IMMERSE THE UNIT OR CABLE ASSEMBLIES IN LIQUID.

THE DEVICE MUST ONLY BE OPERATED USING BATTERY POWER IF THE EARTH CONNECTION IS SUSPECT OR IF THE MAINS LEAD IS DAMAGED OR SUSPECTED OF BEING DAMAGED.

DO NOT USE HIGH TEMPERATURE STERILISATION PROCESSES (SUCH AS AUTOCLAVING). DO NOT USE E-BEAM OR GAMMA RADIATION STERILISATION.

DO NOT USE SOLVENT CLEANERS

USE ONLY ACCESSORIES AND OTHER PARTS RECOMMENDED OR SUPPLIED BY ESAOTE. USE OF OTHER THAN RECOMMENDED OR SUPPLIED PARTS MAY RESULT IN INJURY INACCURATE INFORMATION AND/ OR DAMAGE TO THE UNIT.

THE P80SIX COMPLIES WITH EMC REGULATIONS FOR MEDICAL PRODUCTS WHICH AFFORDS PROTECTION AGAINST EMISSIONS AND ELECTRICAL INTERFERENCE. HOWEVER SPECIAL CARE MUST BE EXERCISED WHEN THE UNIT IS USED WITH HIGH FREQUENCY EQUIPMENT.

IT MUST BE ENSURED THAT NEITHER THE PATIENT NOR THE ELECTRODES (INCLUDING THE NEUTRAL ELECTRODE) COME INTO CONTACT WITH OTHER PERSONS OR CONDUCTING OBJECTS (EVEN IF THESE ARE EARTHED).

THERE IS NO DANGER WHEN USING THE ECG UNIT FOR A PACEMAKER PATIENT OR WITH SIMULTANEOUS USE OF OTHER ELECTRICAL STIMULATION EQUIPMENT. HOWEVER, THE STIMULATION UNITS SHOULD ONLY BE USED AT A SUFFICIENT DISTANCE FROM THE ELECTRODES. IN CASE OF DOUBT, THE PATIENT SHOULD BE DISCONNECTED FROM THE RECORDER.

THIS UNIT IS CF CLASSIFIED ACCORDING TO IEC 601-1. THIS MEANS THAT THE PATIENT CONNECTION IS FULLY ISOLATED AND DEFIBRILLATION PROTECTED. THE MANUFACTURER CAN ONLY GUARANTEE PROTECTION AGAINST DEFIBRILLATION VOLTAGE HOWEVER, WHEN THE ORIGINAL ESAOTE PATIENT CABLE IS USED.

IF SEVERAL UNITS ARE COUPLED THERE IS A DANGER OF SUMMATION OF LEAKAGE CURRENT

DO NOT TOUCH THE CASING DURING DEFIBRILLATION

IF THE PATIENT CABLE SHOULD BECOME DEFECTIVE AFTER DEFIBRILLATION, LEAD OFF WILL BE DISPLAYED AND AN ACOUSTIC ALARM GIVEN

---

## Safety Notices

---

TO PREVENT ELECTRIC SHOCK DO NOT DISASSEMBLE THE UNIT. NO SERVICEABLE PARTS INSIDE. REFER SERVICING TO QUALIFIED PERSONNEL ONLY.

DO NOT USE THIS UNIT IN AREAS WHERE THERE IS ANY DANGER OF EXPLOSION OR THE PRESENCE OF FLAMMABLE GASES SUCH AS ANAESTHETIC AGENTS.

IN THE EVENT OF ACCIDENTAL LCD BREAKAGE AND RESULTANT LEAKAGE OF FLUID, DO NOT INHALE, INGEST OR MAKE CONTACT WITH THE SKIN. IF CONTACT IS MADE RINSE IMMEDIATELY.

THIS PRODUCT IS NOT DESIGNED FOR STERILE USE.

THIS PRODUCT IS NOT DESIGNED FOR OUTDOOR USE.

SWITCH THE UNIT OFF BEFORE CLEANING AND DISCONNECT FROM THE MAINS.

DO NOT, UNDER ANY CIRCUMSTANCES, IMMERSE THE UNIT OR CABLE ASSEMBLIES IN LIQUID.

THE DEVICE MUST ONLY BE OPERATED USING BATTERY POWER IF THE EARTH CONNECTION IS SUSPECT OR IF THE MAINS LEAD IS DAMAGED OR SUSPECTED OF BEING DAMAGED.

DO NOT USE HIGH TEMPERATURE STERILISATION PROCESSES (SUCH AS AUTOCLAVING). DO NOT USE E-BEAM OR GAMMA RADIATION STERILISATION.

DO NOT USE SOLVENT CLEANERS

USE ONLY ACCESSORIES AND OTHER PARTS RECOMMENDED OR SUPPLIED BY ESAOTE. USE OF OTHER THAN RECOMMENDED OR SUPPLIED PARTS MAY RESULT IN INJURY INACCURATE INFORMATION AND/ OR DAMAGE TO THE UNIT.

THE P80SIX COMPLIES WITH EMC REGULATIONS FOR MEDICAL PRODUCTS WHICH AFFORDS PROTECTION AGAINST EMISSIONS AND ELECTRICAL INTERFERENCE. HOWEVER SPECIAL CARE MUST BE EXERCISED WHEN THE UNIT IS USED WITH HIGH FREQUENCY EQUIPMENT.

IT MUST BE ENSURED THAT NEITHER THE PATIENT NOR THE ELECTRODES (INCLUDING THE NEUTRAL ELECTRODE) COME INTO CONTACT WITH OTHER PERSONS OR CONDUCTING OBJECTS (EVEN IF THESE ARE EARTHED).

THERE IS NO DANGER WHEN USING THE ECG UNIT FOR A PACEMAKER PATIENT OR WITH SIMULTANEOUS USE OF OTHER ELECTRICAL STIMULATION EQUIPMENT. HOWEVER, THE STIMULATION UNITS SHOULD ONLY BE USED AT A SUFFICIENT DISTANCE FROM THE ELECTRODES. IN CASE OF DOUBT, THE PATIENT SHOULD BE DISCONNECTED FROM THE RECORDER.

THIS UNIT IS CF CLASSIFIED ACCORDING TO IEC 601-1. THIS MEANS THAT THE PATIENT CONNECTION IS FULLY ISOLATED AND DEFIBRILLATION PROTECTED. THE MANUFACTURER CAN ONLY GUARANTEE PROTECTION AGAINST DEFIBRILLATION VOLTAGE HOWEVER, WHEN THE ORIGINAL ESAOTE PATIENT CABLE IS USED.

IF SEVERAL UNITS ARE COUPLED THERE IS A DANGER OF SUMMATION OF LEAKAGE CURRENT

DO NOT TOUCH THE CASING DURING DEFIBRILLATION

IF THE PATIENT CABLE SHOULD BECOME DEFECTIVE AFTER DEFIBRILLATION, LEAD OFF WILL BE DISPLAYED AND AN ACOUSTIC ALARM GIVEN

---

## Contents - User Guide P80Six

INTRODUCTION .....	2	SETTINGS FOR AUTOMATIC MODE .....	21
OPERATION MODES .....	4	Average Cycles .....	22
Automatic Mode .....	4	Measurements and Markings .....	23
Manual Mode .....	5	Interpretation .....	24
LOCATION & POWER .....	6	Interpretation Settings .....	25
Location .....	6	Selecting Rhythm Leads .....	26
Power Supply .....	6	PATIENT CABLE CONNECTIONS .....	27
BASIC INFORMATION .....	7	Standard Leads .....	29
Switching On and Off .....	7	RECORDING AN ECG IN AUTOMATIC MODE .....	30
Potential Equalisation .....	7	RECORDING AN ECG IN MANUAL MODE .....	32
KEYBOARD .....	8	CARE & MAINTENANCE .....	34
INDICATORS .....	9	Care of your P80Six .....	34
GENERAL SETTINGS .....	10	Self-test .....	34
Defaults .....	11	12 Monthly Check .....	35
Language .....	14	Cleaning the Print Head .....	35
Baseline Filter .....	15	REPLACING THE RECORDING PAPER .....	36
Mains Filter .....	16	TROUBLE SHOOTING .....	38
Myogram Filter .....	17	ORDERING INFORMATION .....	39
Defining Lead Sequence & Printout .....	18	TECHNICAL DATA .....	40
Acoustic QRS Indication .....	19	Available Configurations .....	44
Time / Date .....	20		

## Contents - User Guide P80Six

INTRODUCTION .....	2	SETTINGS FOR AUTOMATIC MODE .....	21
OPERATION MODES .....	4	Average Cycles .....	22
Automatic Mode .....	4	Measurements and Markings .....	23
Manual Mode .....	5	Interpretation .....	24
LOCATION & POWER .....	6	Interpretation Settings .....	25
Location .....	6	Selecting Rhythm Leads .....	26
Power Supply .....	6	PATIENT CABLE CONNECTIONS .....	27
BASIC INFORMATION .....	7	Standard Leads .....	29
Switching On and Off .....	7	RECORDING AN ECG IN AUTOMATIC MODE .....	30
Potential Equalisation .....	7	RECORDING AN ECG IN MANUAL MODE .....	32
KEYBOARD .....	8	CARE & MAINTENANCE .....	34
INDICATORS .....	9	Care of your P80Six .....	34
GENERAL SETTINGS .....	10	Self-test .....	34
Defaults .....	11	12 Monthly Check .....	35
Language .....	14	Cleaning the Print Head .....	35
Baseline Filter .....	15	REPLACING THE RECORDING PAPER .....	36
Mains Filter .....	16	TROUBLE SHOOTING .....	38
Myogram Filter .....	17	ORDERING INFORMATION .....	39
Defining Lead Sequence & Printout .....	18	TECHNICAL DATA .....	40
Acoustic QRS Indication .....	19	Available Configurations .....	44
Time / Date .....	20		

Introduction

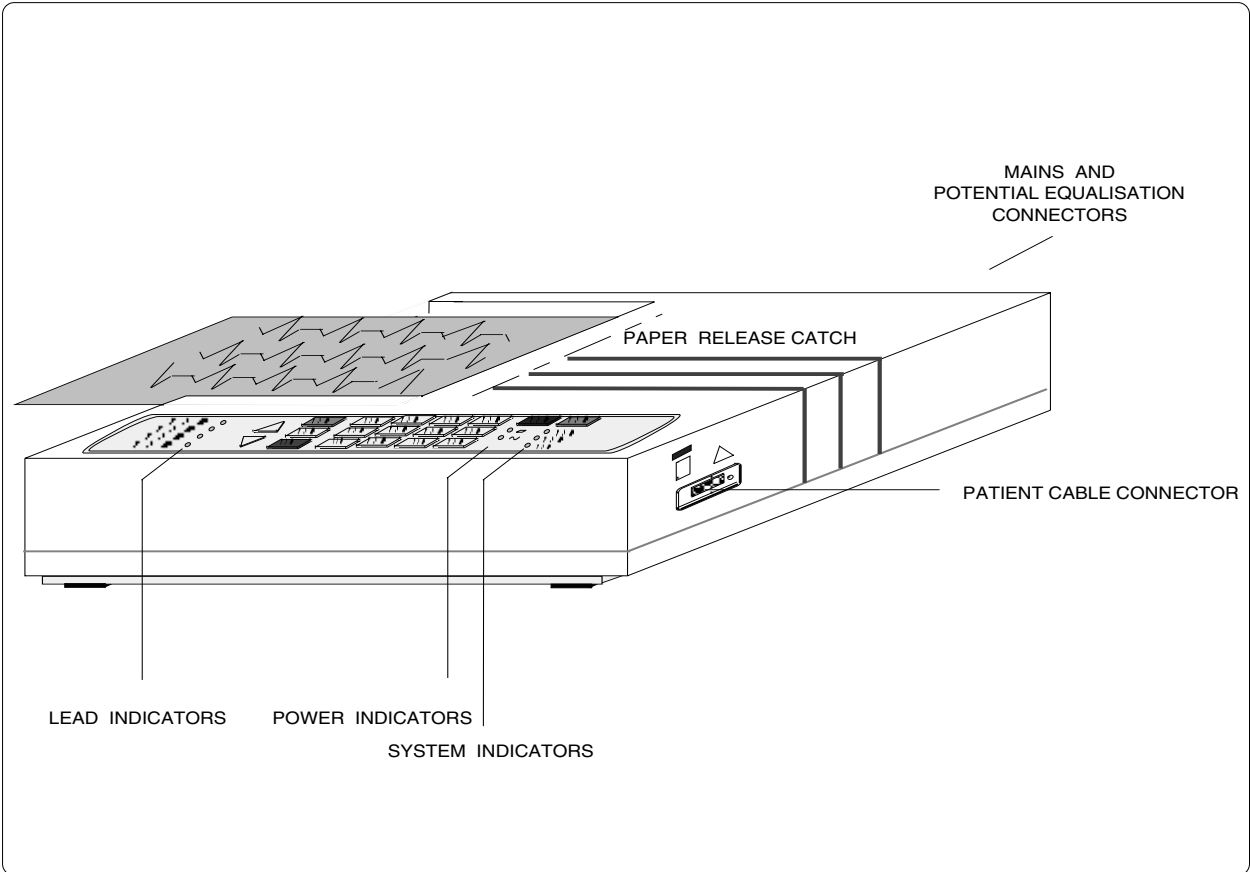

Introduction

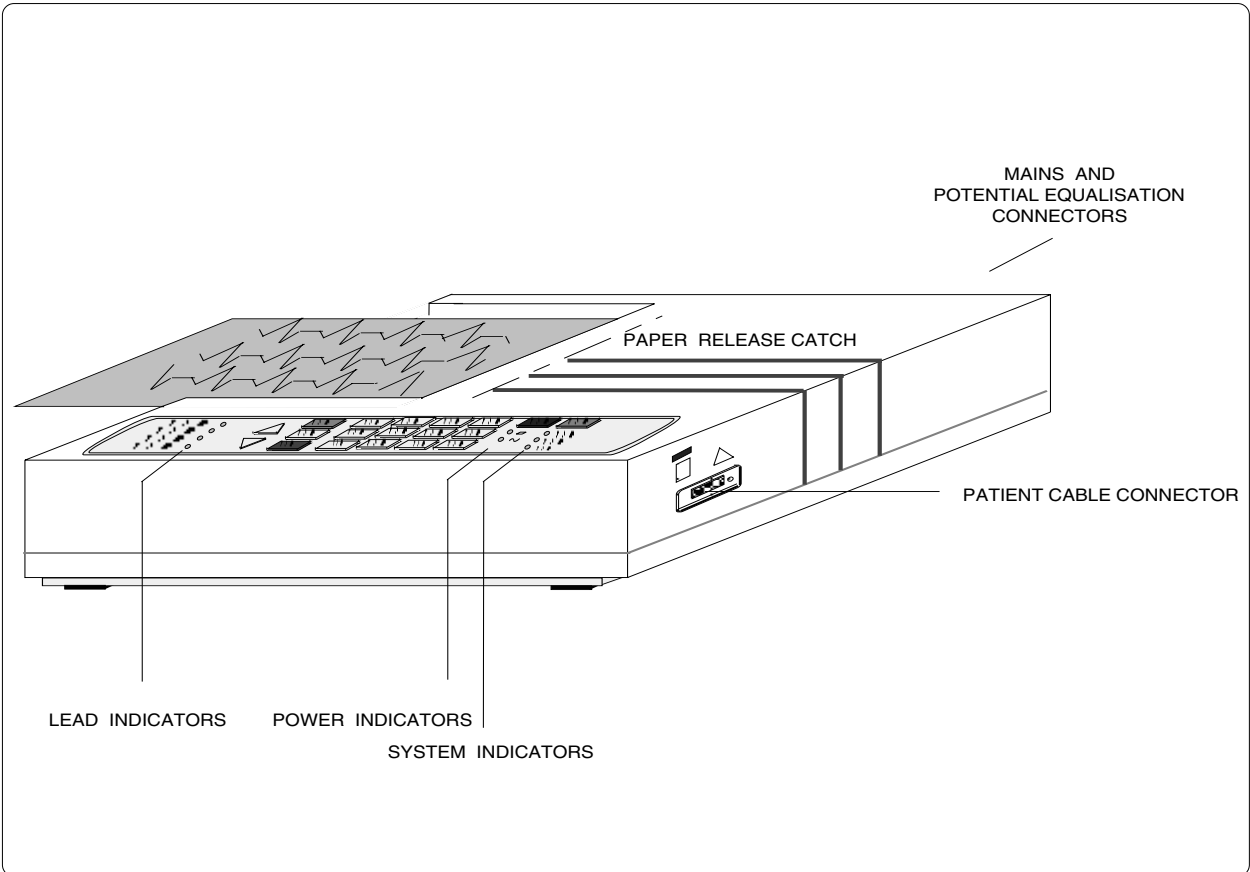



The P80Six is a 12-channel ECG recorder. All ECG signals are simultaneously processed to provide instant ECG recordings. Two automatic recording modes can be individually preset to enable one button ECG recording of preferred print formats .

Individual lamps are provided to give power, paper error, filter, lead group and lead off indications.

In addition, any detected disturbance (i.e. loose electrode or end of paper), gives an audible alarm and the corresponding indicator lamp flashes.

The P80Six includes the following features:

- Low weight and compact dimensions
- Large A4 size printout from integrated quality thermal printer
- Built-in rechargeable battery for mains-independent use
- Simple one key operation
- Automatic or manual recording modes
- Selectable printing formats
- ECG memory for easy copying
- Interpretation program option (including measurements)

The P80Six is a 12-channel ECG recorder. All ECG signals are simultaneously processed to provide instant ECG recordings. Two automatic recording modes can be individually preset to enable one button ECG recording of preferred print formats .

Individual lamps are provided to give power, paper error, filter, lead group and lead off indications.

In addition, any detected disturbance (i.e. loose electrode or end of paper), gives an audible alarm and the corresponding indicator lamp flashes.

The P80Six includes the following features:

- Low weight and compact dimensions
- Large A4 size printout from integrated quality thermal printer
- Built-in rechargeable battery for mains-independent use
- Simple one key operation
- Automatic or manual recording modes
- Selectable printing formats
- ECG memory for easy copying
- Interpretation program option (including measurements)

## *Operation Modes*

### **Automatic Mode**

Automatic Mode provides a printout giving 10 seconds of ECG recording of all 12 leads in 2 different formats.

The following can be programmed freely in each of the formats before recording:

- Lead Format
- Chart Speed
- With the optional interpretation program installed it is also possible to select the measurement table, average cycles with optional markings and interpretation statements for the printout.

For further information see paragraph "Settings for Automatic Mode".

## *Operation Modes*

### **Automatic Mode**

Automatic Mode provides a printout giving 10 seconds of ECG recording of all 12 leads in 2 different formats.

The following can be programmed freely in each of the formats before recording:

- Lead Format
- Chart Speed
- With the optional interpretation program installed it is also possible to select the measurement table, average cycles with optional markings and interpretation statements for the printout.

For further information see paragraph "Settings for Automatic Mode".

### Manual Mode

Manual Mode provides a real time printout of 6 leads that are selected and indicated on the keyboard.

The following can be freely selected before or during recording:

- Lead Group
- Chart Speed
- Sensitivity
- Myogram Filter

For further information see paragraph "ECG Recording in Manual Mode".

### Manual Mode

Manual Mode provides a real time printout of 6 leads that are selected and indicated on the keyboard.

The following can be freely selected before or during recording:

- Lead Group
- Chart Speed
- Sensitivity
- Myogram Filter

For further information see paragraph "ECG Recording in Manual Mode".

## Location & Power

### Location

Do not keep or operate the apparatus in a wet, moist, or dusty environment. Also, avoid exposure to direct sunlight or heat from other sources. Do not allow the unit to come into contact with acidic vapours or liquids, as such contact may cause irreparable damage. The unit should not be placed near X-ray or diathermy units, large transformers or motors.

The unit must be placed on a flat surface. The unit should not be operated in areas where there is any danger of explosion.

### Power Supply

The unit can either be operated from the built-in rechargeable battery, or from the mains.

The mains connection is on the rear of the unit. The mains indicator lamp is always lit when the unit is connected to the mains supply.

A battery indicator lamp confirms battery operation. When the battery capacity is limited, the indicator flashes. To recharge the battery, connect the apparatus to the mains supply by means of the supplied power cable. A totally discharged battery needs less than 15 hours to be fully recharged (60% in less than 3 hours, 90% in less than 7 hours).

A fully charged battery lasts approximately 6 hours of normal use. The unit can remain connected to the mains supply without any danger of damage to either the battery or the unit.

## Location & Power

### Location

Do not keep or operate the apparatus in a wet, moist, or dusty environment. Also, avoid exposure to direct sunlight or heat from other sources. Do not allow the unit to come into contact with acidic vapours or liquids, as such contact may cause irreparable damage. The unit should not be placed near X-ray or diathermy units, large transformers or motors.

The unit must be placed on a flat surface. The unit should not be operated in areas where there is any danger of explosion.

### Power Supply



The unit can either be operated from the built-in rechargeable battery, or from the mains.

The mains connection is on the rear of the unit. The mains indicator lamp is always lit when the unit is connected to the mains supply.

A battery indicator lamp confirms battery operation. When the battery capacity is limited, the indicator flashes. To recharge the battery, connect the apparatus to the mains supply by means of the supplied power cable. A totally discharged battery needs less than 15 hours to be fully recharged (60% in less than 3 hours, 90% in less than 7 hours).

A fully charged battery lasts approximately 6 hours of normal use. The unit can remain connected to the mains supply without any danger of damage to either the battery or the unit.

**Switching On and Off**

The P80Six is switched on by means of the on  key and off by means of the off  key.



The unit is switched off after 5 minutes (30 seconds if battery capacity is limited) if no key is pressed and the patient cable is not connected.

**Potential Equalisation**

If the P80Six is used in conjunction with other patient connected equipment, we recommend that the potential equalisation stud (  ) on the rear of the unit is connected to the hospital/ building common ground with the yellow/green ground cable..

When working from an emergency vehicle, the vehicle common ground can be used.

**Switching On and Off**

The P80Six is switched on by means of the on  key and off by means of the off  key.















The unit is switched off after 5 minutes (30 seconds if battery capacity is limited) if no key is pressed and the patient cable is not connected.

**Potential Equalisation**















If the P80Six is used in conjunction with other patient connected equipment, we recommend that the potential equalisation stud (  ) on the rear of the unit is connected to the hospital/ building common ground with the yellow/green ground cable..









When working from an emergency vehicle, the vehicle common ground can be used.









## Keyboard

	Switch unit on		Cancel or enable QRS beeper
	Switch unit off		Automatic ECG sensitivity adjustment from 10 to 5 mm/mV in order to avoid overlapping traces in automatic mode only
	Copy stored ECG		ECG sensitivity selector (5, 10 or 20 mm/mV) manual recording only
	Start automatic recording		Chart speed selector (5, 25 or 50 mm/s) manual recording only
	Start manual recording		Key for 1 mV indication mark on output during manual recording. Use this key also for baseline recentering
	Stop recording/move paper to start position		Key for initiation of setups and selection of second format for printout
	Switch myogram filter (muscle tremor filter) on or off		
	Lead group selector (forward)		
	Lead group selector (backward)		

## Keyboard

	Switch unit on		Cancel or enable QRS beeper
	Switch unit off		Automatic ECG sensitivity adjustment from 10 to 5 mm/mV in order to avoid overlapping traces in automatic mode only
	Copy stored ECG		ECG sensitivity selector (5, 10 or 20 mm/mV) manual recording only
	Start automatic recording		Chart speed selector (5, 25 or 50 mm/s) manual recording only
	Start manual recording		Key for 1 mV indication mark on output during manual recording. Use this key also for baseline recentering
	Stop recording/move paper to start position		Key for initiation of setups and selection of second format for printout
	Switch myogram filter (muscle tremor filter) on or off		
	Lead group selector (forward)		
	Lead group selector (backward)		

		Mains indicator (lit when mains connected)		
		Battery lamp (lit when running on battery power - mains not connected) (blinking when battery capacity is limited)		
		INOP Warning lamp for loose electrode connection or poor electrode contact		
		PAPER Warning lamp for end of paper or paper jam		
		FILTER Myogram filter (lit when filter ON)		
<hr/>				
I aVR	II aVL	III aVF		Indicator lamp for selected lead group (Standard) (Cabrera: aVL, I, -aVR, II, aVF, III) in manual mode only
V1 V4	V2 V5	V3 V6		Indicator lamp for selected lead group (Standard) (in manual mode only)
II V2	aVF V4	III V5		Indicator lamp for selected lead group in manual mode only
V4 V7	V5 V8	V6 V9		Indicator lamp for selected lead group in manual mode only.

		Mains indicator (lit when mains connected)		
		Battery lamp (lit when running on battery power - mains not connected) (blinking when battery capacity is limited)		
		INOP Warning lamp for loose electrode connection or poor electrode contact		
		PAPER Warning lamp for end of paper or paper jam		
		FILTER Myogram filter (lit when filter ON)		
<hr/>				
I aVR	II aVL	III aVF		Indicator lamp for selected lead group (Standard) (Cabrera: aVL, I, -aVR, II, aVF, III) in manual mode only
V1 V4	V2 V5	V3 V6		Indicator lamp for selected lead group (Standard) (in manual mode only)
II V2	aVF V4	III V5		Indicator lamp for selected lead group in manual mode only
V4 V7	V5 V8	V6 V9		Indicator lamp for selected lead group in manual mode only.

## General Settings

Each parameter is set by means of a code. This code comprises a combination starting with the **SHIFT** key followed by a number of keys and is always confirmed with the **STOP** key. As soon as the **SHIFT** key is pressed, the keyboard is dedicated to the programming function.

The setting is remembered and the keyboard is only released for other functions when the **STOP** key is pressed. Once the settings have been confirmed, they are stored in the memory even when the unit is switched off. As an example, if you want to set the language on your P80Six to English, proceed as follows:

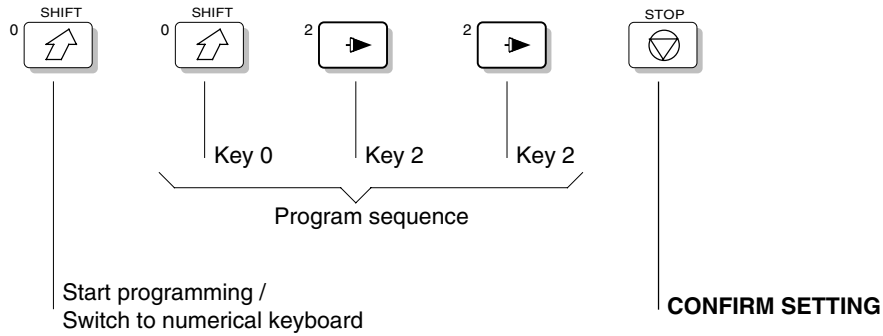

On the following pages the programmable parameters and the programming sequences are described in detail.

NOTE THAT THE SETTINGS ARE ALWAYS CONFIRMED BY PRESSING THE  KEY.

## General Settings

Each parameter is set by means of a code. This code comprises a combination starting with the **SHIFT** key followed by a number of keys and is always confirmed with the **STOP** key. As soon as the **SHIFT** key is pressed, the keyboard is dedicated to the programming function.

The setting is remembered and the keyboard is only released for other functions when the **STOP** key is pressed. Once the settings have been confirmed, they are stored in the memory even when the unit is switched off. As an example, if you want to set the language on your P80Six to English, proceed as follows:

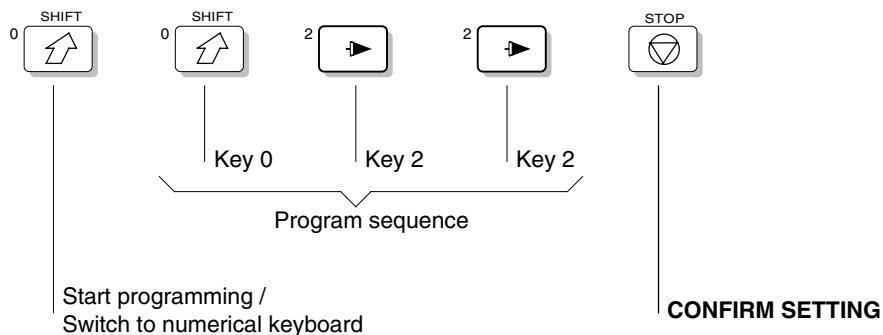

On the following pages the programmable parameters and the programming sequences are described in detail.

NOTE THAT THE SETTINGS ARE ALWAYS CONFIRMED BY PRESSING THE  KEY.



Defaults

Default Settings		
Setting	P80Six	P80Six with Interpretation Option
Language	English	English
Leads	Standard (S)	Standard (S)
Format 1	ECG: 25mm/s short (o)	ECG: 25 mm/s, short (o)
		MECG: 2 x 6 (50 mm/s) + 2
		Measurements: suppressed (-)
		Marks: enabled (+)
		Interpretation: enabled (+)
Format 2	ECG: 25 mm/s, long (ooo)	ECG: 25 mm/s, long (ooo)
		MECG: none (-)
		Measurements: disabled (-)
		Marks: enabled (+)
		Interpretation: disabled (-)
Rhythm Leads	V1 = ECG; V1, II = MECG	V1 = ECG; V1, II = MECG
Autom. Centering	Enabled (+)	Enabled (+)
Printout of Signals	Sequential	Sequential
Baseline Filter Setting	0.05 Hz	0.05 Hz
Mains Filter Setting	50 Hz (USA - 60Hz)	50 Hz (USA - 60Hz)
Myogram Filter Setting	35 Hz, OFF	35 Hz, OFF
Interpretation Settings		N/A: - U: + A30: - S: -

Defaults

Default Settings		
Setting	P80Six	P80Six with Interpretation Option
Language	English	English
Leads	Standard (S)	Standard (S)
Format 1	ECG: 25mm/s short (o)	ECG: 25 mm/s, short (o)
		MECG: 2 x 6 (50 mm/s) + 2
		Measurements: suppressed (-)
		Marks: enabled (+)
		Interpretation: enabled (+)
Format 2	ECG: 25 mm/s, long (ooo)	ECG: 25 mm/s, long (ooo)
		MECG: none (-)
		Measurements: disabled (-)
		Marks: enabled (+)
		Interpretation: disabled (-)
Rhythm Leads	V1 = ECG; V1, II = MECG	V1 = ECG; V1, II = MECG
Autom. Centering	Enabled (+)	Enabled (+)
Printout of Signals	Sequential	Sequential
Baseline Filter Setting	0.05 Hz	0.05 Hz
Mains Filter Setting	50 Hz (USA - 60Hz)	50 Hz (USA - 60Hz)
Myogram Filter Setting	35 Hz, OFF	35 Hz, OFF
Interpretation Settings		N/A: - U: + A30: - S: -

## General Settings

The defined formats and settings can be checked as follows:

Setup Printout				
Entry Key Sequence				Action
SHIFT	0	1	1	Printout of programmed settings

A printout of the defined settings will be produced and gives the following information, depending on the installed software:

Unit designation (P80Six),	Software option installed (C = Interpretation) and Software version
Serial number	For service use
Leads	Standard (S) or Cabrera (C)
ECG Format	Long (ooo), Short (o) or Suppressed (-)
MECG	Average cycles as defined in auto ECG recording setup (e.g. 4 * 3 (25 mm/s)+2)
Measurements	Enabled (+) or Suppressed (-)
Marks	Enabled (+) or Suppressed (-)
Interpretation	Enabled (+) or Suppressed (-)
Selected Rhythm leads	Leads selected for R1, R2 resp.
Automatic Centering	Enabled (+) or Suppressed (-)
Printout of signals	Sequential or Simultaneous

## General Settings

The defined formats and settings can be checked as follows:

Setup Printout				
Entry Key Sequence				Action
SHIFT	0	1	1	Printout of programmed settings

A printout of the defined settings will be produced and gives the following information, depending on the installed software:

Unit designation (P80Six),	Software option installed (C = Interpretation) and Software version
Serial number	For service use
Leads	Standard (S) or Cabrera (C)
ECG Format	Long (ooo), Short (o) or Suppressed (-)
MECG	Average cycles as defined in auto ECG recording setup (e.g. 4 * 3 (25 mm/s)+2)
Measurements	Enabled (+) or Suppressed (-)
Marks	Enabled (+) or Suppressed (-)
Interpretation	Enabled (+) or Suppressed (-)
Selected Rhythm leads	Leads selected for R1, R2 resp.
Automatic Centering	Enabled (+) or Suppressed (-)
Printout of signals	Sequential or Simultaneous

## General Settings

Baseline Filter	0.05, 0.15 or 0.30 Hz
Mains Filter	50, 60 Hz or OFF (-)
Myogram Filter	25 or 35 Hz, ON (+) or OFF (-)
Interpretation settings:	N/A: +/- ('normal/abnormal' is written (+) or suppressed (-); U: +/- ('unconfirmed report' is written (+) or suppressed (-); A30: +/- (patient age is assumed to be < 30 (-) or >30 (+); S: +/- (low (-) or high (+) sensitivity)

To reset the unit to the basic default settings, proceed as follows:

Reset Setup				
Entry Key Sequence				Action
SHIFT	0	6	6	Reset to default base settings.

## General Settings

Baseline Filter	0.05, 0.15 or 0.30 Hz
Mains Filter	50, 60 Hz or OFF (-)
Myogram Filter	25 or 35 Hz, ON (+) or OFF (-)
Interpretation settings:	N/A: +/- ('normal/abnormal' is written (+) or suppressed (-); U: +/- ('unconfirmed report' is written (+) or suppressed (-); A30: +/- (patient age is assumed to be < 30 (-) or >30 (+); S: +/- (low (-) or high (+) sensitivity)

To reset the unit to the basic default settings, proceed as follows:

Reset Setup				
Entry Key Sequence				Action
SHIFT	0	6	6	Reset to default base settings.

## General Settings

### Language

The language is selected as follows:

Select Language					
Entry Key Sequence			Language	Confirm	
SHIFT	0	2	1	German	Press STOP Key
			2	English	
			3	French	
			4	Swedish	
			5	American	
			6	Italian	
			7	Spanish	
			8	Portuguese	
			9	Russian	

Confirm the selection by pressing **STOP**.

*Notes: Once selected, the language remains active. However, when the unit is reset to the default settings, the default language will be English.*

## General Settings

### Language

The language is selected as follows:

Select Language					
Entry Key Sequence			Language	Confirm	
SHIFT	0	2	1	German	Press STOP Key
			2	English	
			3	French	
			4	Swedish	
			5	American	
			6	Italian	
			7	Spanish	
			8	Portuguese	
			9	Russian	

Confirm the selection by pressing **STOP**.

*Notes: Once selected, the language remains active. However, when the unit is reset to the default settings, the default language will be English.*

There are three different filters which can be set individually as follows:

- Baseline filter
- Mains filter
- Myogram filter

The setting for each filter is given on the setup printout.

**Baseline Filter**

The digital **Baseline filter** suppresses excessive baseline drifts. The setting options are as follows:

Baseline Filter				
Entry Key Sequence		Filter Setting		Confirm
SHIFT	5	0	0.05 Hz (Default)	Press STOP Key
		1	0.15 Hz	
		3	0.30 Hz	

The set value is the lower limit of the frequency range and is normally set to 0.05 Hz. The settings 0.15 and 0.30 Hz should only be used when absolutely necessary, as the possibility exists that they could affect the original ECG signal, especially the ST segments.

Confirm the selection by pressing **STOP**.

There are three different filters which can be set individually as follows:

- Baseline filter
- Mains filter
- Myogram filter

The setting for each filter is given on the setup printout.

**Baseline Filter**

The digital **Baseline filter** suppresses excessive baseline drifts. The setting options are as follows:

Baseline Filter				
Entry Key Sequence		Filter Setting		Confirm
SHIFT	5	0	0.05 Hz (Default)	Press STOP Key
		1	0.15 Hz	
		3	0.30 Hz	

The set value is the lower limit of the frequency range and is normally set to 0.05 Hz. The settings 0.15 and 0.30 Hz should only be used when absolutely necessary, as the possibility exists that they could affect the original ECG signal, especially the ST segments.

Confirm the selection by pressing **STOP**.

## General Settings

### Mains Filter

The **Mains filter** is an adaptive digital interference filter designed to suppress AC interference without attenuating or distorting the ECG.

Set the mains filter in accordance with the frequency of your local mains supply as follows:

Mains Filter				
Entry Key Sequence		Filter Setting		Confirm
SHIFT	8	5	Mains Filter 50 Hz	Press STOP Key
		6	Mains Filter 60 Hz	
		9	Mains Filter off	

## General Settings

### Mains Filter

The **Mains filter** is an adaptive digital interference filter designed to suppress AC interference without attenuating or distorting the ECG.

Set the mains filter in accordance with the frequency of your local mains supply as follows:

Mains Filter				
Entry Key Sequence		Filter Setting		Confirm
SHIFT	8	5	Mains Filter 50 Hz	Press STOP Key
		6	Mains Filter 60 Hz	
		9	Mains Filter off	

**Myogram Filter**

The **Myogram filter** suppresses disturbances caused by strong muscle tremor. The cutoff frequency of the myogram filter is set to 25 or 35 Hz. The myogram filter is switched on and off manually with the **FILTER** key. Switching on or off can also be programmed as default when the unit is switched on. When the filter is active, the '**FILTER**' lamp on the unit is lit.

Myogram Filter			
Entry Key Sequence		Setting	Confirm
SHIFT	8	2	Myogram Filter 25 Hz
		3	Myogram Filter 35 Hz
		1	Myo. Filt. ON when switching on unit (marked on printout with +)
		8	Myo. Filt. OFF when switching on unit (marked on printout with -)
			Press STOP Key

Confirm the selection by pressing **STOP**.

An ECG recorded in auto mode is stored unfiltered. It is therefore possible to print the stored ECG either with or without passing the myogram filter.

General Settings

**Myogram Filter**

The **Myogram filter** suppresses disturbances caused by strong muscle tremor. The cutoff frequency of the myogram filter is set to 25 or 35 Hz. The myogram filter is switched on and off manually with the **FILTER** key. Switching on or off can also be programmed as default when the unit is switched on. When the filter is active, the '**FILTER**' lamp on the unit is lit.

Myogram Filter			
Entry Key Sequence		Setting	Confirm
SHIFT	8	2	Myogram Filter 25 Hz
		3	Myogram Filter 35 Hz
		1	Myo. Filt. ON when switching on unit (marked on printout with +)
		8	Myo. Filt. OFF when switching on unit (marked on printout with -)
			Press STOP Key

Confirm the selection by pressing **STOP**.

An ECG recorded in auto mode is stored unfiltered. It is therefore possible to print the stored ECG either with or without passing the myogram filter.

## General Settings

### Defining Lead Sequence & Printout

The required settings can be selected as follows:

Sequences & Print			
Entry Key Sequence		Definition	Confirm
SHIFT	7	1	Standard Lead Sequence
		2	Cabrera Lead Sequence
		3	Simultaneous Print
		4	Sequential Print
		5	Auto-Centering ON
		6	Auto-Centering OFF
			Press STOP Key

Confirm the selection by pressing **STOP**.

The selectable lead groups for the P80Six are:

Lead Groups							
Standard				Cabrera			
I	V1	II	V4	aVL	V1	II	V4
II	V2	aVF	V5	I	V2	aVF	V5
III	V3	III	V6	-aVR	V3	III	V6
aVR	V4	V2	V7	II	V4	V2	V7
aVL	V5	V4	V8	aVF	V5	V4	V8
aVF	V6	V5	V9	III	V6	V5	V9

\* Leads V7, V8 and V9 are only available when leads V1, V2 and V3 resp. are moved to the corresponding positions (manual mode).

## General Settings

### Defining Lead Sequence & Printout

The required settings can be selected as follows:

Sequences & Print			
Entry Key Sequence		Definition	Confirm
SHIFT	7	1	Standard Lead Sequence
		2	Cabrera Lead Sequence
		3	Simultaneous Print
		4	Sequential Print
		5	Auto-Centering ON
		6	Auto-Centering OFF
			Press STOP Key

Confirm the selection by pressing **STOP**.

The selectable lead groups for the P80Six are:

Lead Groups							
Standard				Cabrera			
I	V1	II	V4	aVL	V1	II	V4
II	V2	aVF	V5	I	V2	aVF	V5
III	V3	III	V6	-aVR	V3	III	V6
aVR	V4	V2	V7	II	V4	V2	V7
aVL	V5	V4	V8	aVF	V5	V4	V8
aVF	V6	V5	V9	III	V6	V5	V9

\* Leads V7, V8 and V9 are only available when leads V1, V2 and V3 resp. are moved to the corresponding positions (manual mode).



The selectable printout forms are:

Simultaneous	All ECG leads are printed in the same time segment (in automatic mode only).
Sequential	Each group is a contiguous time segment of approximately 2.5 or 5 seconds (in automatic mode only).
Auto-Centering ON	All ECG traces are centred dynamically for optimal use of paper width.
Auto-Centering OFF	ECG traces are set to a fixed baseline position and may possibly overlap.

**Acoustic QRS Indication**

The acoustic QRS indication can be switched on or off at any time by pressing the  key.

The selectable printout forms are:

Simultaneous	All ECG leads are printed in the same time segment (in automatic mode only).
Sequential	Each group is a contiguous time segment of approximately 2.5 or 5 seconds (in automatic mode only).
Auto-Centering ON	All ECG traces are centred dynamically for optimal use of paper width.
Auto-Centering OFF	ECG traces are set to a fixed baseline position and may possibly overlap.

**Acoustic QRS Indication**

The acoustic QRS indication can be switched on or off at any time by pressing the  key.

## General Settings

### Time / Date

CHANGE TIME / DATE						
<b>Time:</b>						
SHIFT	9	1	1	HHMMSS	beep	
<b>Date:</b>						
SHIFT	9	2	2	DDMMYY	beep	
<b>Wintertime to Summertime (+1 Hr)</b>						
SHIFT	9	4	4			
<b>Summertime to Wintertime (-1 Hr)</b>						
SHIFT	9	5	5			

## General Settings

### Time / Date

CHANGE TIME / DATE						
<b>Time:</b>						
SHIFT	9	1	1	HHMMSS	beep	
<b>Date:</b>						
SHIFT	9	2	2	DDMMYY	beep	
<b>Wintertime to Summertime (+1 Hr)</b>						
SHIFT	9	4	4			
<b>Summertime to Wintertime (-1 Hr)</b>						
SHIFT	9	5	5			

## Settings for Automatic Mode

Two separate formats for the automatic ECG output can be selected as follows:

Automatic ECG Format		
Entry Key Sequence		Setup Format
SHIFT	1	Setup Format 1
	2	Setup Format 2

With this the 2 automatic mode formats are defined as detailed on the following pages.

The ECG format is set as follows:

ECG Format					
Entry Key Sequence			Output Format	Confirm	
SHIFT	1 or 2	1	0	Leads are printed in format 4 x 3 + 1 Rhy	Press STOP Key
			1	1 page, 12 leads, 25mm/s	
			2	1 page, 12 leads: 8 leads 5s, 4 leads 10s	
			5	No leads are printed	
			6	Leads are printed in short form (1 sheet)	
			7	Leads are printed in long form (2 sheets)	
			8	Chart speed is 25 mm/s	
			9	Chart speed is 50 mm/s	

Confirm the selection by pressing **STOP**.

*Note: Lead selection for the rhythm lead is defined on page 26.*

## Settings for Automatic Mode

Two separate formats for the automatic ECG output can be selected as follows:

Automatic ECG Format		
Entry Key Sequence		Setup Format
SHIFT	1	Setup Format 1
	2	Setup Format 2

With this the 2 automatic mode formats are defined as detailed on the following pages.

The ECG format is set as follows:

ECG Format					
Entry Key Sequence			Output Format	Confirm	
SHIFT	1 or 2	1	0	Leads are printed in format 4 x 3 + 1 Rhy	Press STOP Key
			1	1 page, 12 leads, 25mm/s	
			2	1 page, 12 leads: 8 leads 5s, 4 leads 10s	
			5	No leads are printed	
			6	Leads are printed in short form (1 sheet)	
			7	Leads are printed in long form (2 sheets)	
			8	Chart speed is 25 mm/s	
			9	Chart speed is 50 mm/s	

Confirm the selection by pressing **STOP**.

*Note: Lead selection for the rhythm lead is defined on page 26.*

## Settings for Automatic Mode

### Average Cycles

The Average cycles are defined as follows:

Average Cycles (Interpretation Option only)					
Entry Key Sequence			Output Format		Confirm
SHIFT	1 or 2	2	5	No average cycles are printed.	Press STOP Key
			6	4 * 3 (25 mm/s) + 2 * Rhy (25 mm/s) The average complexes are printed out in four groups of three leads with 2 rhythm leads at a chart speed of 25 mm/s.	
			7	4 * 3 (50 mm/s) + 2 * Rhy (25 mm/s) The average complexes are printed out in four groups of three leads with 2 rhythm leads at a chart speed of 50 mm/s.	
			8	2 * 6 (50 mm/s) + 2 * Rhy (25 mm/s) The average complexes are printed out in two groups of six leads with two rhythm leads at a chart speed of 50 mm/s.	

Confirm the selection by pressing **STOP**.

*Note: Lead selection for the 2 rhythm leads is defined on page 26.*

## Settings for Automatic Mode

### Average Cycles

The Average cycles are defined as follows:

Average Cycles (Interpretation Option only)					
Entry Key Sequence			Output Format		Confirm
SHIFT	1 or 2	2	5	No average cycles are printed.	Press STOP Key
			6	4 * 3 (25 mm/s) + 2 * Rhy (25 mm/s) The average complexes are printed out in four groups of three leads with 2 rhythm leads at a chart speed of 25 mm/s.	
			7	4 * 3 (50 mm/s) + 2 * Rhy (25 mm/s) The average complexes are printed out in four groups of three leads with 2 rhythm leads at a chart speed of 50 mm/s.	
			8	2 * 6 (50 mm/s) + 2 * Rhy (25 mm/s) The average complexes are printed out in two groups of six leads with two rhythm leads at a chart speed of 50 mm/s.	

Confirm the selection by pressing **STOP**.

*Note: Lead selection for the 2 rhythm leads is defined on page 26.*

**Measurements and Markings**

To define the measurements and markings proceed as follows:

<b>Measurements and Markings (Interpretation Option only)</b>					
<i>Entry Key Sequence</i>			<i>Output Format</i>	<i>Confirm</i>	
SHIFT	1 or 2	3	5	Detailed table of measurement results is omitted (However, the values of electrical axes, intervals, and heart rate are not suppressed.).	Press STOP Key
			6	Detailed table of measurement results is printed.	
			7	Reference markings (beginning and end of P wave and QRS as well as end of T wave) are omitted.	
			8	Reference markings (beginning and end of P wave and QRS as well as end of T wave) are added to ECG cycles.	

Confirm the selection by pressing **STOP**.

**Measurements and Markings**

To define the measurements and markings proceed as follows:

<b>Measurements and Markings (Interpretation Option only)</b>					
<i>Entry Key Sequence</i>			<i>Output Format</i>	<i>Confirm</i>	
SHIFT	1 or 2	3	5	Detailed table of measurement results is omitted (However, the values of electrical axes, intervals, and heart rate are not suppressed.).	Press STOP Key
			6	Detailed table of measurement results is printed.	
			7	Reference markings (beginning and end of P wave and QRS as well as end of T wave) are omitted.	
			8	Reference markings (beginning and end of P wave and QRS as well as end of T wave) are added to ECG cycles.	

Confirm the selection by pressing **STOP**.

## Settings for Automatic Mode

### Interpretation (Option)

To print or suppress interpretation statements on the printout proceed as follows:

Interpretation					
Entry Key Sequence			Output Format		Confirm
SHIFT	1 or 2	4	5	Interpretation is omitted.	Press STOP Key
			6	Interpretation is printed.	

Confirm the selection by pressing **STOP**.

Full details of the interpretation option are given in the ECG Measurement and Interpretation booklet.

## Settings for Automatic Mode

### Interpretation (Option)

To print or suppress interpretation statements on the printout proceed as follows:

Interpretation					
Entry Key Sequence			Output Format		Confirm
SHIFT	1 or 2	4	5	Interpretation is omitted.	Press STOP Key
			6	Interpretation is printed.	

Confirm the selection by pressing **STOP**.

Full details of the interpretation option are given in the ECG Measurement and Interpretation booklet.

**Interpretation Settings**

The Interpretation settings enable the user to determine whether or not certain comments will be added to the interpretation statements on the ECG printout. Furthermore, the patient's age can be defined (< or > 30) and if low or high sensitivity should be applied. Low sensitivity will suppress certain nonspecific ECG diagnosis; this may be advisable when carrying out ECGs for screening.

Interpretation Settings			
Entry Key Sequence		Setting	Confirm
SHIFT	6	1	'Normal/abnormal' is not printed
		2	'Normal/abnormal' is printed.
		3	'Unconfirmed report' is not printed.
		4	'Unconfirmed report' is printed.
		5	Patient age is assumed to be < 30
		6	Patient age is assumed to be > 30
		7	Low sensitivity
		8	High sensitivity
			Press STOP Key

## Settings for Automatic Mode

**Interpretation Settings**

The Interpretation settings enable the user to determine whether or not certain comments will be added to the interpretation statements on the ECG printout. Furthermore, the patient's age can be defined (< or > 30) and if low or high sensitivity should be applied. Low sensitivity will suppress certain nonspecific ECG diagnosis; this may be advisable when carrying out ECGs for screening.

Interpretation Settings			
Entry Key Sequence		Setting	Confirm
SHIFT	6	1	'Normal/abnormal' is not printed
		2	'Normal/abnormal' is printed.
		3	'Unconfirmed report' is not printed.
		4	'Unconfirmed report' is printed.
		5	Patient age is assumed to be < 30
		6	Patient age is assumed to be > 30
		7	Low sensitivity
		8	High sensitivity
			Press STOP Key

## Settings for Automatic Mode

### Selecting Rhythm Leads

The rhythm leads are printed out as defined. Two separate rhythm leads can be selected. The following formats can be set:

Rhythm Leads		
Entry Key Sequence		Setup Lead
SHIFT	3	Setup Rhythm Lead 1
	4	Setup Rhythm Lead 2

The 2 rhythm leads are defined as follows:

Extremity Leads					
Entry Key Sequence			Lead	Confirm	
SHIFT	3 or 4	8	1	I	Press STOP Key
			2	II	
			3	III	
			4	aVR	
			5	aVL	
			6	aVF	

Precordial Leads					
Entry Key Sequence			Lead	Confirm	
SHIFT	3 or 4	9	1	V1	Press STOP Key
			2	V2	
			3	V3	
			4	V4	
			5	V5	
			6	V6	

Confirm the selection by pressing **STOP**.

## Settings for Automatic Mode

### Selecting Rhythm Leads

The rhythm leads are printed out as defined. Two separate rhythm leads can be selected. The following formats can be set:

Rhythm Leads		
Entry Key Sequence		Setup Lead
SHIFT	3	Setup Rhythm Lead 1
	4	Setup Rhythm Lead 2

The 2 rhythm leads are defined as follows:

Extremity Leads					
Entry Key Sequence			Lead	Confirm	
SHIFT	3 or 4	8	1	I	Press STOP Key
			2	II	
			3	III	
			4	aVR	
			5	aVL	
			6	aVF	

Precordial Leads					
Entry Key Sequence			Lead	Confirm	
SHIFT	3 or 4	9	1	V1	Press STOP Key
			2	V2	
			3	V3	
			4	V4	
			5	V5	
			6	V6	

Confirm the selection by pressing **STOP**.



The accessory kit of the electrocardiograph includes a 10-lead patient cable. This cable is plugged into the patient cable socket on the right-hand side of the unit and secured with the two screws.

The P80Six is CF rated. The patient connection is fully isolated and defibrillation protected. Protection against defibrillation voltage is however only ensured, if the original ESAOTE patient cable (Part-no. 9740410001 / USA: 9740410002) is used. Make sure that during ECG recording neither the patient nor the conducting parts of the patient connection or the electrodes (including the neutral electrode) come into contact with other persons or conducting objects (even if these are earthed).

The accessory kit of the electrocardiograph includes a 10-lead patient cable. This cable is plugged into the patient cable socket on the right-hand side of the unit and secured with the two screws.

The P80Six is CF rated. The patient connection is fully isolated and defibrillation protected. Protection against defibrillation voltage is however only ensured, if the original ESAOTE patient cable (Part-no. 9740410001 / USA: 9740410002) is used. Make sure that during ECG recording neither the patient nor the conducting parts of the patient connection or the electrodes (including the neutral electrode) come into contact with other persons or conducting objects (even if these are earthed).

## Patient Cable Connections

The quality of the ECG is dependent on the preparation and the resistance between the skin and the electrode. To ensure a good quality ECG and minimise the skin/electrode resistance, remember the following points:

1. Ensure that the patient is warm and relaxed.
2. Shave electrode area before cleaning.
3. Thoroughly clean the area with alcohol.
4. Place the **C4** electrode first - in the fifth intercostal space on midclavicular line. Then place:
  - **C1** in fourth intercostal space at the right sternal border
  - **C2** in fourth intercostal space at the left sternal border
  - **C3** between, and equidistant to, C4 and C2
  - **C6** on left midaxillary line on the same level as C4
  - **C5** between, and equidistant to, C4 and C6

Following these simple guidelines will ensure good results every time.

## Patient Cable Connections

The quality of the ECG is dependent on the preparation and the resistance between the skin and the electrode. To ensure a good quality ECG and minimise the skin/electrode resistance, remember the following points:

1. Ensure that the patient is warm and relaxed.
2. Shave electrode area before cleaning.
3. Thoroughly clean the area with alcohol.
4. Place the **C4** electrode first - in the fifth intercostal space on midclavicular line. Then place:
  - **C1** in fourth intercostal space at the right sternal border
  - **C2** in fourth intercostal space at the left sternal border
  - **C3** between, and equidistant to, C4 and C2
  - **C6** on left midaxillary line on the same level as C4
  - **C5** between, and equidistant to, C4 and C6

Following these simple guidelines will ensure good results every time.

**Standard Leads**

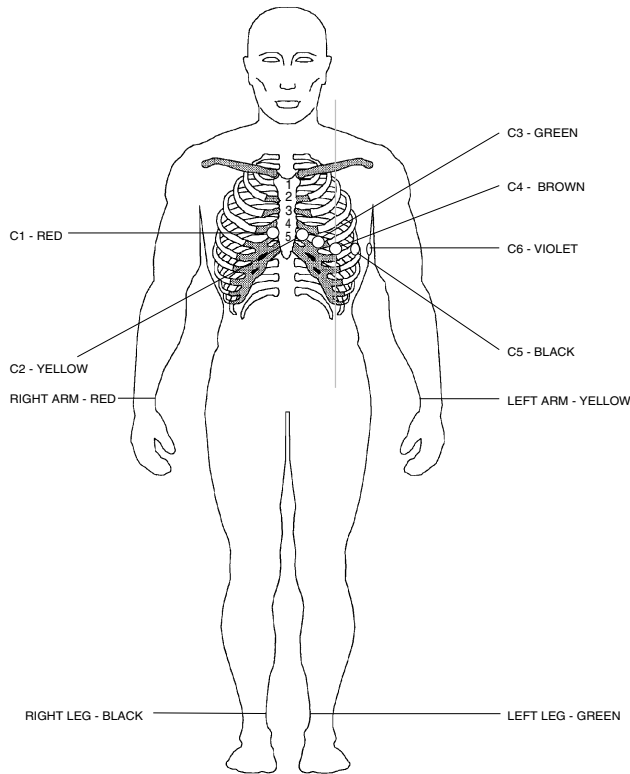

IEC		AHA	
N	Black	RL	Green
R	Red	RA	White
C1	White/Red	V1	Brown/Red
C2	White/Yellow	V2	Brown/Yellow
C3	White/Green	V3	Brown/Green
C4	White/Brown	V4	Brown/Blue
C5	White/Black	V5	Brown/Orange
C6	White/Violet	V6	Brown/Violet
L	Yellow	LA	Black
F	Green	LL	Red

**Standard Leads**

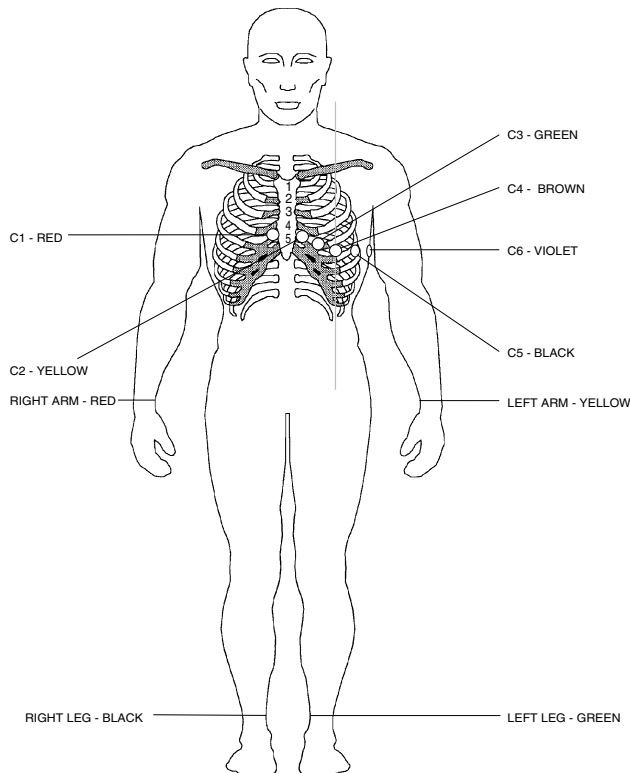

IEC		AHA	
N	Black	RL	Green
R	Red	RA	White
C1	White/Red	V1	Brown/Red
C2	White/Yellow	V2	Brown/Yellow
C3	White/Green	V3	Brown/Green
C4	White/Brown	V4	Brown/Blue
C5	White/Black	V5	Brown/Orange
C6	White/Violet	V6	Brown/Violet
L	Yellow	LA	Black
F	Green	LL	Red

## Recording an ECG in Automatic Mode

In **automatic mode**, a full 12-lead ECG is printed in one of two predefined formats with a sensitivity of 10 mm/mV. These two formats are selected by the user to suit his specific needs and requirements (as detailed previously).

When the  key is pressed before recording in automatic mode, the unit detects very large waveform amplitudes and sets the sensitivity for the extremity and/or precordial leads to 5 mm/mV to reduce the overlapping of traces.

To start the automatic ECG recording in Format 1, simply press .

To start the automatic recording in the second format, press  followed by .

## Recording an ECG in Automatic Mode

In **automatic mode**, a full 12-lead ECG is printed in one of two predefined formats with a sensitivity of 10 mm/mV. These two formats are selected by the user to suit his specific needs and requirements (as detailed previously).

When the  key is pressed before recording in automatic mode, the unit detects very large waveform amplitudes and sets the sensitivity for the extremity and/or precordial leads to 5 mm/mV to reduce the overlapping of traces.

To start the automatic ECG recording in Format 1, simply press .

To start the automatic recording in the second format, press  followed by .



The printout provides you with the following information:

- ECG recording of all leads in either Standard or Cabrera format according to selection
- Sensitivity
- Heart Rate
- Speed
- Filter Settings
- Patient Data field to manually insert patient data

and if set:

- Average Cycles (Interpretation option only)
- Intervals (Interpretation option only)
- Axis (Interpretation option only)
- Sokolow Index (ECG index for hypertrophy; Interpretation option only)
- Detailed Measurement Table (Interpretation option only)
- Interpretation (Interpretation option only)

- To obtain an extra printout of the ECG recording in Format 1, simply press  .

- To obtain an extra printout of the second format, press  followed by  .

## Recording an ECG in Automatic Mode



The printout provides you with the following information:

- ECG recording of all leads in either Standard or Cabrera format according to selection
- Sensitivity
- Heart Rate
- Speed
- Filter Settings
- Patient Data field to manually insert patient data

and if set:

- Average Cycles (Interpretation option only)
- Intervals (Interpretation option only)
- Axis (Interpretation option only)
- Sokolow Index (ECG index for hypertrophy; Interpretation option only)
- Detailed Measurement Table (Interpretation option only)
- Interpretation (Interpretation option only)



- To obtain an extra printout of the ECG recording in Format 1, simply press  .

- To obtain an extra printout of the second format, press  followed by  .

## Recording an ECG in Manual Mode

**Manual mode** provides a direct printout of the real-time ECG with full control of parameter selection.







The following can be freely chosen during or before the recording:

- Lead Group (by means of the  and  keys)

The following lead groups are selectable:

- I, II, III, aVR, aVL, aVF (Cabrera: aVL, I, -aVR, II, aVF, III)
- V1, V2, V3, V4, V5, V6
- II, aVF, III, V2, V4, V5
- V4, V5, V6, V7, V8, V9



*\* Leads V7, V8 and V9 are only available when leads V1, V2 and V3 resp. are moved to the corresponding positions.*

- Chart Speed (by means of the ,  and  keys)
- Sensitivity (by means of the ,  and  keys)
- Filter see page 17.

## Recording an ECG in Manual Mode

**Manual mode** provides a direct printout of the real-time ECG with full control of parameter selection.







The following can be freely chosen during or before the recording:

- Lead Group (by means of the  and  keys)

The following lead groups are selectable:

- I, II, III, aVR, aVL, aVF (Cabrera: aVL, I, -aVR, II, aVF, III)
- V1, V2, V3, V4, V5, V6
- II, aVF, III, V2, V4, V5
- V4, V5, V6, V7, V8, V9

*\* Leads V7, V8 and V9 are only available when leads V1, V2 and V3 resp. are moved to the corresponding positions.*

- Chart Speed (by means of the ,  and  keys)
- Sensitivity (by means of the ,  and  keys)
- Filter see page 17.

To start the manual recording of a real-time ECG, press the  key.

The printout provides you with the following information:

- The group of the six selected leads with lead identification.
- On the lower edge chart speed, sensitivity and filter settings (if on) are given.
- At the top, the heart rate as current average of 4 beats is shown.

To re-centre the ECG traces, press the  key during operation.

Finish the recording by pressing the  key.

---

**WARNING:**

AFTER HEAVY ARTEFACTS OR LEAD OFF, THE INDICATION OF THE HEART RATE  
MAY NOT BE RELIABLE.

---

To start the manual recording of a real-time ECG, press the  key.

The printout provides you with the following information:

- The group of the six selected leads with lead identification.
- On the lower edge chart speed, sensitivity and filter settings (if on) are given.
- At the top, the heart rate as current average of 4 beats is shown.

To re-centre the ECG traces, press the  key during operation.

Finish the recording by pressing the  key.

---

**WARNING:**

AFTER HEAVY ARTEFACTS OR LEAD OFF, THE INDICATION OF THE HEART RATE  
MAY NOT BE RELIABLE.

---

**Care of your P80Six**

The patient cable should not be exposed to excessive mechanical stress. Whenever disconnecting the leads, hold the plugs and not the cables. Align the leads in such a way as to prevent anyone stumbling over them or any damage caused by the wheels of instrument trolleys. The cable can be wiped with soapy water. Sterilization, if required, should be done with gas only and not with steam. To disinfect, wipe the cable with any standard hospital disinfectant.

The casing of the P80Six should be cleaned with a soft cloth on the surface only.

**DISCONNECT THE UNIT BEFORE CLEANING. DO NOT, UNDER ANY CIRCUMSTANCES, IMMERSE THE APPARATUS INTO A CLEANING LIQUID OR STERILIZE WITH HOT WATER, STEAM, OR AIR.**

---

**Self-test**

Initiate a self-test of the P80Six as follows:

Initiate Self-Test				
Entry Key Sequence				Action
SHIFT	0	3	3	Printout of Self-test

A table giving information for the service staff is printed out.

**Care of your P80Six**

The patient cable should not be exposed to excessive mechanical stress. Whenever disconnecting the leads, hold the plugs and not the cables. Align the leads in such a way as to prevent anyone stumbling over them or any damage caused by the wheels of instrument trolleys. The cable can be wiped with soapy water. Sterilization, if required, should be done with gas only and not with steam. To disinfect, wipe the cable with any standard hospital disinfectant.

The casing of the P80Six should be cleaned with a soft cloth on the surface only.

**DISCONNECT THE UNIT BEFORE CLEANING. DO NOT, UNDER ANY CIRCUMSTANCES, IMMERSE THE APPARATUS INTO A CLEANING LIQUID OR STERILIZE WITH HOT WATER, STEAM, OR AIR.**

---

**Self-test**

Initiate a self-test of the P80Six as follows:

Initiate Self-Test				
Entry Key Sequence				Action
SHIFT	0	3	3	Printout of Self-test

A table giving information for the service staff is printed out.



### 12 Monthly Check

The unit should undergo a technical safety check every 12 months. This safety check should extend to include the following:

- Visual inspection of the unit and cables.
- Electrical safety tests according to IEC 601-1 and IEC 601-2-25.
- Functional tests according to the Service Handbook.

The test results must be documented.

### Cleaning the Print Head

If the printer is used a lot, a residue of printers ink (from the grid on the printer paper) can build up on the print head. This can cause the print quality to deteriorate. We recommend therefore that every month the print head is cleaned with alcohol as follows:

- Remove the paper tray. The printhead is found under, and in from, the paper tray release catch.
- With a tissue dampened with alcohol, gently rub the print head to remove the ink residue. If the printhead is badly soiled, the colour of the grid ink will show on the tissue.

### 12 Monthly Check

The unit should undergo a technical safety check every 12 months. This safety check should extend to include the following:

- Visual inspection of the unit and cables.
- Electrical safety tests according to IEC 601-1 and IEC 601-2-25.
- Functional tests according to the Service Handbook.

The test results must be documented.

### Cleaning the Print Head

If the printer is used a lot, a residue of printers ink (from the grid on the printer paper) can build up on the print head. This can cause the print quality to deteriorate. We recommend therefore that every month the print head is cleaned with alcohol as follows:

- Remove the paper tray. The printhead is found under, and in from, the paper tray release catch.
- With a tissue dampened with alcohol, gently rub the print head to remove the ink residue. If the printhead is badly soiled, the colour of the grid ink will show on the tissue.

## *Replacing the Recording Paper*

The recording paper must be replaced as soon as the end of the paper is indicated by a red stripe on the lower edge. After the indication first appears, there are about 8 pages left. However, we recommend that the paper be replaced immediately.

If no paper is left, the printing process is interrupted and the paper warning lamp starts to blink. After the paper has been replaced, the printout is restarted by pressing **COPY** or **MAN START** or **AUTO START**.

A step-by-step description of how to change the paper is given on the next page.

## *Replacing the Recording Paper*

The recording paper must be replaced as soon as the end of the paper is indicated by a red stripe on the lower edge. After the indication first appears, there are about 8 pages left. However, we recommend that the paper be replaced immediately.

If no paper is left, the printing process is interrupted and the paper warning lamp starts to blink. After the paper has been replaced, the printout is restarted by pressing **COPY** or **MAN START** or **AUTO START**.

A step-by-step description of how to change the paper is given on the next page.

## Replacing the Recording Paper

- Place fingers under the retaining bar and pull directly upwards. The paper tray cover releases.
- Withdraw the cover from the unit. **DO NOT FORCE, THE PAPER TRAY COVER RUNS FREELY OVER THE DEDICATED RUNNERS.**
- Remove any remaining paper from the paper tray.
- Place a new paper pack into the paper tray with the printed (grid) side facing upwards.
- Place the beginning of the paper over the black paper roller on the paper tray cover.
- Return the paper tray cover in position and press firmly until secure.
- Press the **STOP** key to transport the paper to the start position.

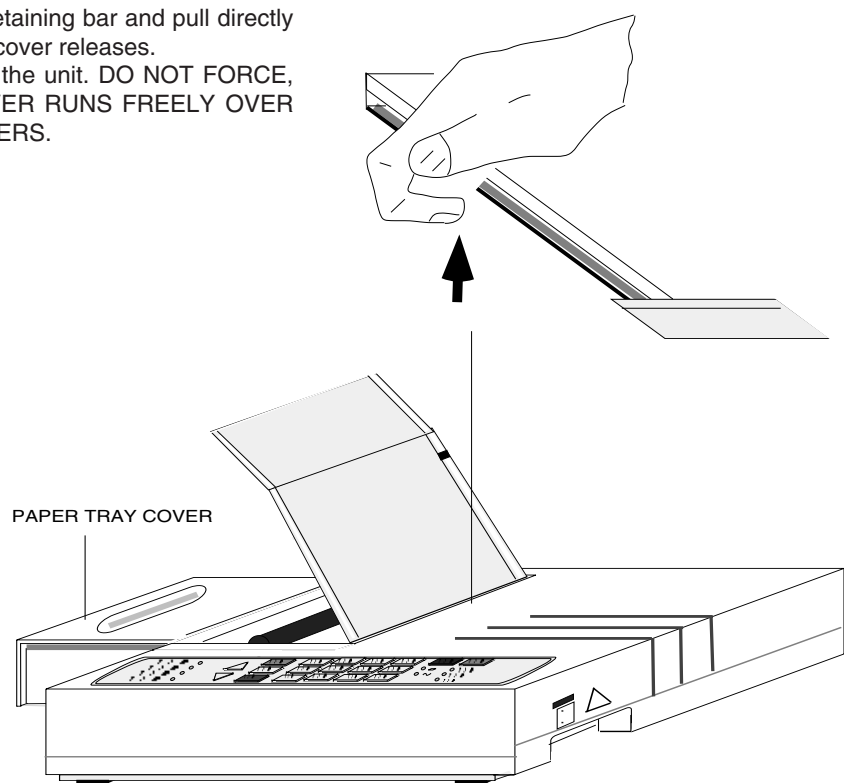

*ESAOTE can only guarantee perfect printouts when ESAOTE original chart paper or chart paper of the same quality is used.*

## Replacing the Recording Paper

- Place fingers under the retaining bar and pull directly upwards. The paper tray cover releases.
- Withdraw the cover from the unit. **DO NOT FORCE, THE PAPER TRAY COVER RUNS FREELY OVER THE DEDICATED RUNNERS.**
- Remove any remaining paper from the paper tray.
- Place a new paper pack into the paper tray with the printed (grid) side facing upwards.
- Place the beginning of the paper over the black paper roller on the paper tray cover.
- Return the paper tray cover in position and press firmly until secure.
- Press the **STOP** key to transport the paper to the start position.

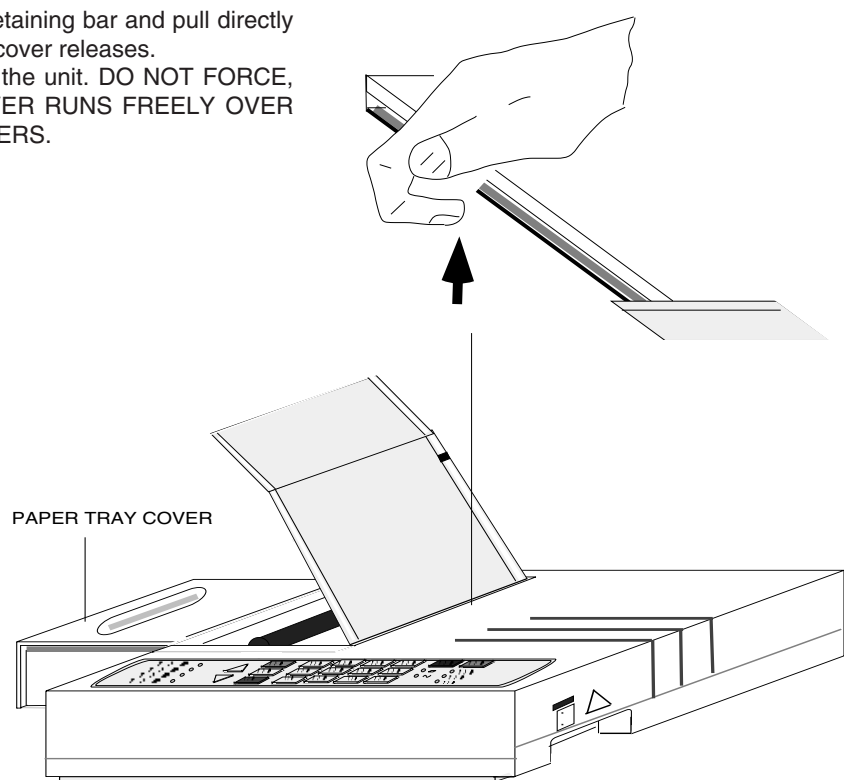

*ESAOTE can only guarantee perfect printouts when ESAOTE original chart paper or chart paper of the same quality is used.*

## Trouble Shooting

<b>Problem</b>	<b>What to Check</b>
Unit does not switch On/ Mains Indicator Lamp is not lit	Check if mains cable is plugged in. Call your local ESAOTE dealer if problem is still present.
"Noisy" traces	CHECK ELECTRODE CONTACT. As much as possible, ensure that patient is relaxed and warm. Activate myogram filter to reduce muscle tremor. Check mains filter to 50 or 60 Hz according to local power supply.
ECG trace 'wanders' away from centre	Baseline drift - check electrode contact. Press 1mV key to reset baseline. Select a higher baseline frequency.
Poor quality printout / ECG traces 'breaking up'	Thermal print head dirty - clean printhead with alcohol. Possible faulty printhead, contact local service centre. Ensure that the paper tray cover is clicked into place
No printout	Connect unit to the mains supply. Ensure that the paper tray cover is clicked into place. Check paper level.

## Trouble Shooting

<b>Problem</b>	<b>What to Check</b>
Unit does not switch On/ Mains Indicator Lamp is not lit	Check if mains cable is plugged in. Call your local ESAOTE dealer if problem is still present.
"Noisy" traces	CHECK ELECTRODE CONTACT. As much as possible, ensure that patient is relaxed and warm. Activate myogram filter to reduce muscle tremor. Check mains filter to 50 or 60 Hz according to local power supply.
ECG trace 'wanders' away from centre	Baseline drift - check electrode contact. Press 1mV key to reset baseline. Select a higher baseline frequency.
Poor quality printout / ECG traces 'breaking up'	Thermal print head dirty - clean printhead with alcohol. Possible faulty printhead, contact local service centre. Ensure that the paper tray cover is clicked into place
No printout	Connect unit to the mains supply. Ensure that the paper tray cover is clicked into place. Check paper level.

## Ordering Information

Your local representative stocks all the disposables and accessories available for the P80Six. In case of difficulty or to obtain the address of your local dealer, please contact the head office. Our staff will be pleased to help process your order or to provide any details for all ESAOTE products.

### Complete Units

P80Six Basic, 230 V; Complete with standard accessories .....	9840400110
P80Six Interpretation, 230 V; Complete with standard accessories .....	9840400120
Standard Accessories:	
Patient cable EURO colours; pack of paper; set of ten electrodes	
ECG gel; User Guide	
P80Six Basic, 115 V; Complete with standard accessories .....	9840400111
P80Six Interpretation, 115 V; Complete with standard accessories .....	9840400121
Standard Accessories:	
Patient cable USA colours; pack of paper; set of ten electrodes	
ECG gel; User Guide.	

### Accessories

- 10-lead Patient Cable, Euro .....	9740410001
- 10-lead Patient Cable, USA .....	9740410002
- 4 Extremity clamp-electrodes .....	9610020000
- 4 Extremity clamp-electrodes, USA colour .....	9610020001
- 6 Suction electrodes .....	9610054000
- ECG electrode cream (100 ml) .....	9210091133
- Recording Paper, Z-folded (1 Pack) .....	9690029100
- Carrying Case .....	To be defined
- Trolley .....	9704250100
- Patient Cable Holder .....	9101341000
- User Guide I, F, D .....	9740440011
- User Guide GB, E, P .....	9740440015

## Ordering Information

Your local representative stocks all the disposables and accessories available for the P80Six. In case of difficulty or to obtain the address of your local dealer, please contact the head office. Our staff will be pleased to help process your order or to provide any details for all ESAOTE products.

### Complete Units

P80Six Basic, 230 V; Complete with standard accessories .....	9840400110
P80Six Interpretation, 230 V; Complete with standard accessories .....	9840400120
Standard Accessories:	
Patient cable EURO colours; pack of paper; set of ten electrodes	
ECG gel; User Guide	
P80Six Basic, 115 V; Complete with standard accessories .....	9840400111
P80Six Interpretation, 115 V; Complete with standard accessories .....	9840400121
Standard Accessories:	
Patient cable USA colours; pack of paper; set of ten electrodes	
ECG gel; User Guide.	

### Accessories

- 10-lead Patient Cable, Euro .....	9740410001
- 10-lead Patient Cable, USA .....	9740410002
- 4 Extremity clamp-electrodes .....	9610020000
- 4 Extremity clamp-electrodes, USA colour .....	9610020001
- 6 Suction electrodes .....	9610054000
- ECG electrode cream (100 ml) .....	9210091133
- Recording Paper, Z-folded (1 Pack) .....	9690029100
- Carrying Case .....	To be defined
- Trolley .....	9704250100
- Patient Cable Holder .....	9101341000
- User Guide I, F, D .....	9740440011
- User Guide GB, E, P .....	9740440015

## Technical Data

*Technical data subject to change without notice.*

<b>Dimensions</b>	399 x 104 x 338 mm
<b>Weight</b>	4.25 kg ( 5.05 kg with full paper tray)
<b>Mains Supply</b>	100 to 115 / 220 to 240 VAC, 50/60 Hz
<b>Battery</b>	Built-in 12 V lead-acid battery (rechargeable)
<b>Power Consumption</b>	Recording: 28 VA max
<b>Leads</b>	Standard / Cabrera
<b>Paper Speed</b>	5 / 25 / 50 mm/s (direct)
<b>Sensitivity</b>	5 / 10 / 20 mm/mV, either automatically adjusted or manually selected
<b>Chart Paper</b>	Thermoreactive - Z-folded, 210 mm wide, perforation 280 mm
<b>Printing Process</b>	High-resolution thermal print head, 8 dots per mm
<b>Recording Tracks (man)</b>	6 channels, automatic baseline adjustment
<b>Automatic Lead Programs</b>	12 channel representation

## Technical Data

*Technical data subject to change without notice.*

<b>Dimensions</b>	399 x 104 x 338 mm
<b>Weight</b>	4.25 kg ( 5.05 kg with full paper tray)
<b>Mains Supply</b>	100 to 115 / 220 to 240 VAC, 50/60 Hz
<b>Battery</b>	Built-in 12 V lead-acid battery (rechargeable)
<b>Power Consumption</b>	Recording: 28 VA max
<b>Leads</b>	Standard / Cabrera
<b>Paper Speed</b>	5 / 25 / 50 mm/s (direct)
<b>Sensitivity</b>	5 / 10 / 20 mm/mV, either automatically adjusted or manually selected
<b>Chart Paper</b>	Thermoreactive - Z-folded, 210 mm wide, perforation 280 mm
<b>Printing Process</b>	High-resolution thermal print head, 8 dots per mm
<b>Recording Tracks (man)</b>	6 channels, automatic baseline adjustment
<b>Automatic Lead Programs</b>	12 channel representation

<b>Data Record:</b>	Listing of ECG recording data
	<i>Version C: ECG measurement results (intervals, amplitudes, electrical axes), Sokolow Index, average complexes with optional measurement reference markings, and interpretation.</i>
<b>ECG Storage:</b>	Memory for 10 s, 12-lead ECG
	Circular input memory for 10 s, 12-lead ECG.
<b>Frequency Range of Digital Recorder:</b>	
	0 to 150 Hz (IEC)
	0 to 150 Hz (AHA)

<b>Data Record:</b>	Listing of ECG recording data
	<i>Version C: ECG measurement results (intervals, amplitudes, electrical axes), Sokolow Index, average complexes with optional measurement reference markings, and interpretation.</i>
<b>ECG Storage:</b>	Memory for 10 s, 12-lead ECG
	Circular input memory for 10 s, 12-lead ECG.
<b>Frequency Range of Digital Recorder:</b>	
	0 to 150 Hz (IEC)
	0 to 150 Hz (AHA)

<b>ECG Amplifier:</b>	Simultaneous, synchronous registration of all 9 active electrode signals (= 12 standard leads)
	Sampling frequency: 1000 Hz
	Digital resolution: 5 $\mu$ V
	Dynamic range: $\pm$ 10 mVAC
	Max. electrode potential: $\pm$ 300 mVDC
	Time constant: 3.2 s
	Frequency response: 0.05 to 150 Hz (-3 dB)
	Input impedance: $>$ 10 M $\Omega$
<b>Myogram Filter (muscle tremor filter)</b>	
	25 Hz or 35 Hz, programmable (not active on averaged waveform). The stored ECGs can be printed with or without filter.
<b>Line Frequency Filter:</b>	Distortion-free suppression of superimposed 50 or 60 Hz sinusoidal interferences by means of an adaptive digital filter.
<b>Patient Input:</b>	Fully floating and isolated, defibrillation protected.
<b>Patient Leakage Current:</b>	$<$ 5 $\mu$ A

<b>ECG Amplifier:</b>	Simultaneous, synchronous registration of all 9 active electrode signals (= 12 standard leads)
	Sampling frequency: 1000 Hz
	Digital resolution: 5 $\mu$ V
	Dynamic range: $\pm$ 10 mVAC
	Max. electrode potential: $\pm$ 300 mVDC
	Time constant: 3.2 s
	Frequency response: 0.05 to 150 Hz (-3 dB)
	Input impedance: $>$ 10 M $\Omega$
<b>Myogram Filter (muscle tremor filter)</b>	
	25 Hz or 35 Hz, programmable (not active on averaged waveform). The stored ECGs can be printed with or without filter.
<b>Line Frequency Filter:</b>	Distortion-free suppression of superimposed 50 or 60 Hz sinusoidal interferences by means of an adaptive digital filter.
<b>Patient Input:</b>	Fully floating and isolated, defibrillation protected.
<b>Patient Leakage Current:</b>	$<$ 5 $\mu$ A



## Technical Data

<b>Safety Standard:</b>	CF according to IEC and complying with the following
	RL 93/42/EEC
	EN 60601-1:1990
	IEC 601-1
	IEC 601-2-25:1993
	pr EN 1441:1994
<b>EMC:</b>	CISPR 111: 1985, EN 55011: 1992
	IEC 801-2: 1991
	IEC 801-3: 1984
	IEC 801-4: 1988
	IEC 801-5:
<b>Safety Class:</b>	I according to IEC 601-1 (with internal power supply)
	Ila according to RL 93/42/EEC, CE-0123
<b>Environmental Conditions:</b>	Temperature, Operating: 10° to 40° C
	Temperature, Storage: -10° to 50° C
	Relative humidity: 25 to 95% (non condensing)
	Atmospheric pressure: 700 to 1060 hPa
<b>Control Panel:</b>	Rubber keys

*Technical data subject to change without notice.*

## Technical Data

<b>Safety Standard:</b>	CF according to IEC and complying with the following
	RL 93/42/EEC
	EN 60601-1:1990
	IEC 601-1
	IEC 601-2-25:1993
	pr EN 1441:1994
<b>EMC:</b>	CISPR 111: 1985, EN 55011: 1992
	IEC 801-2: 1991
	IEC 801-3: 1984
	IEC 801-4: 1988
	IEC 801-5:
<b>Safety Class:</b>	I according to IEC 601-1 (with internal power supply)
	Ila according to RL 93/42/EEC, CE-0123
<b>Environmental Conditions:</b>	Temperature, Operating: 10° to 40° C
	Temperature, Storage: -10° to 50° C
	Relative humidity: 25 to 95% (non condensing)
	Atmospheric pressure: 700 to 1060 hPa
<b>Control Panel:</b>	Rubber keys

*Technical data subject to change without notice.*

**Available Configurations**

The P80Six is available in two versions:

---

**Standard Version:** Unit with ECG recording and printout capabilities.

---

**Version C:** Unit with additional ECG Interpretation program (including measurements).

---

**Available Configurations**

The P80Six is available in two versions:

---

**Standard Version:** Unit with ECG recording and printout capabilities.

---

**Version C:** Unit with additional ECG Interpretation program (including measurements).

---